

PIN CONFIGURATION

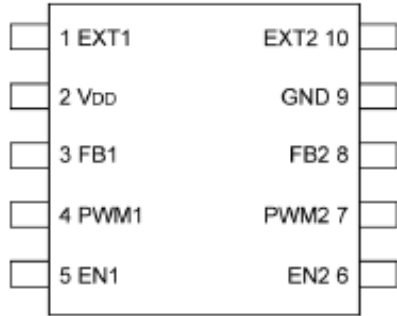

MSOP-10
(TOP VIEW)

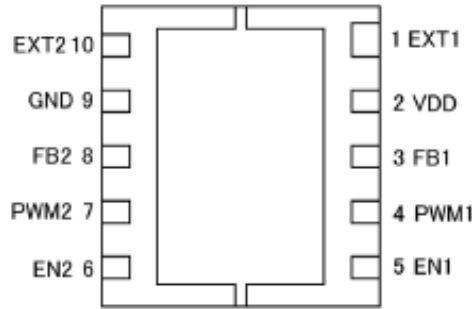

USP-10
(BOTTOM VIEW)

●MSOP-10

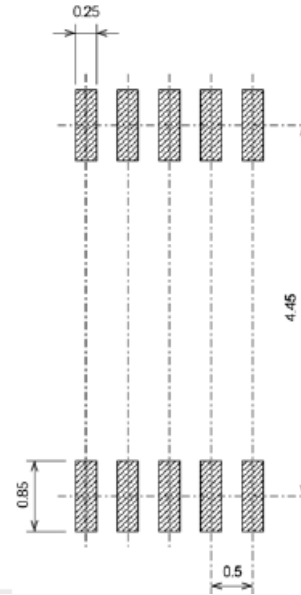

●USP-10

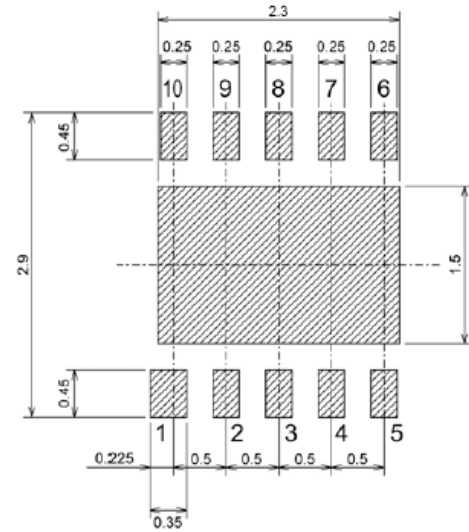

Note: Recommended metal design

PACKAGING INFORMATION

●MSOP-10

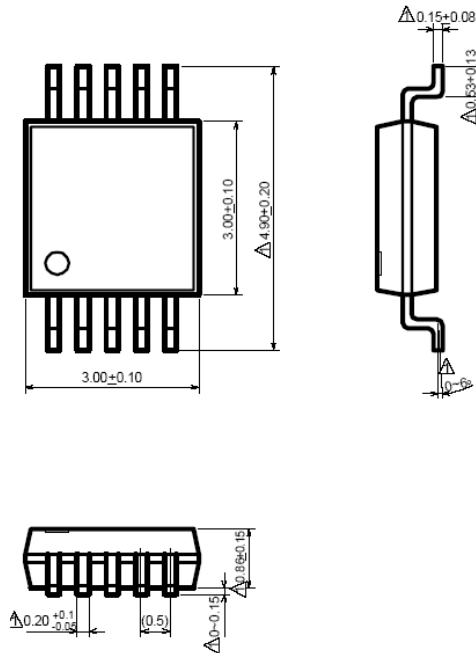

●USP-10

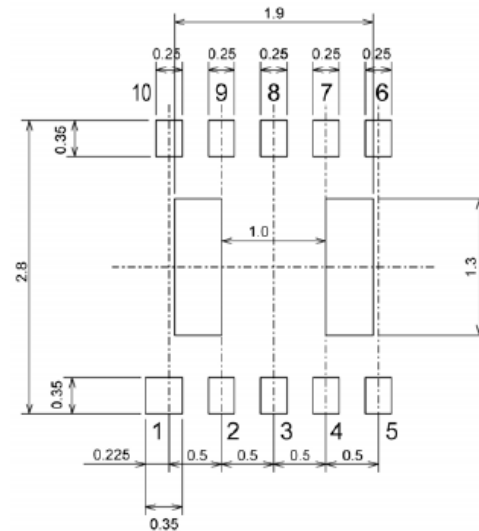
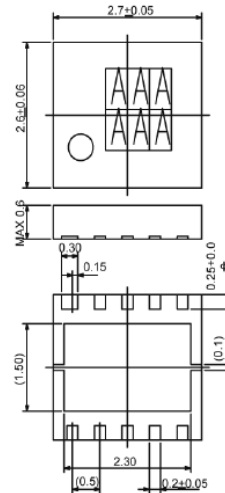

* Soldering fillet surface is not formed because the sides of the pins are not plated.