

## ■ PIN CONFIGURATION

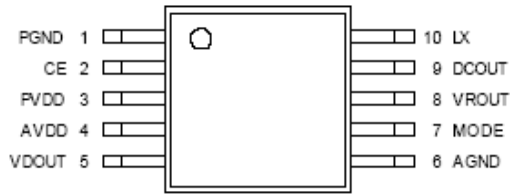

MSOP-10 (TOP VIEW)

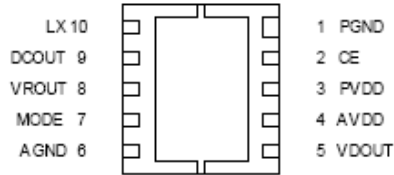

\*Please do not connect a heat dissipation pad to the circuitry. If the pad needs to be connected to other pins, it should be connected to the AGND pin.

## ● MSOP-10

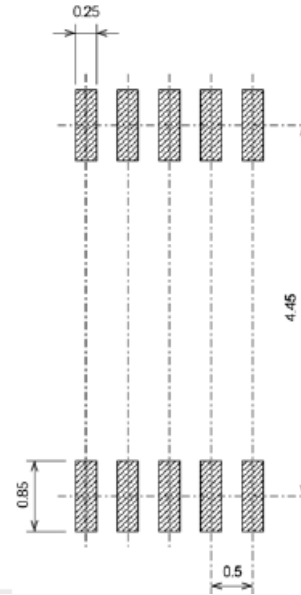

## ● USP-10

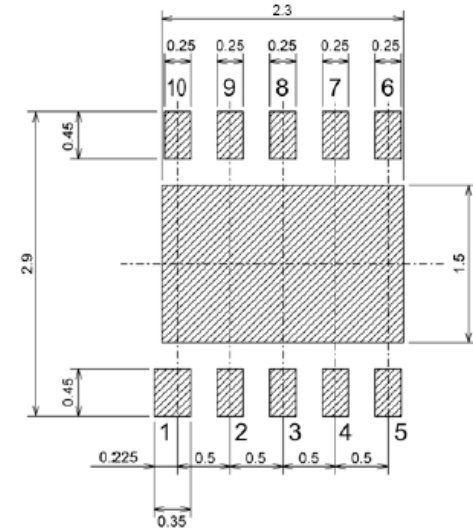

## ■ PACKAGING INFORMATION

### ● MSOP-10

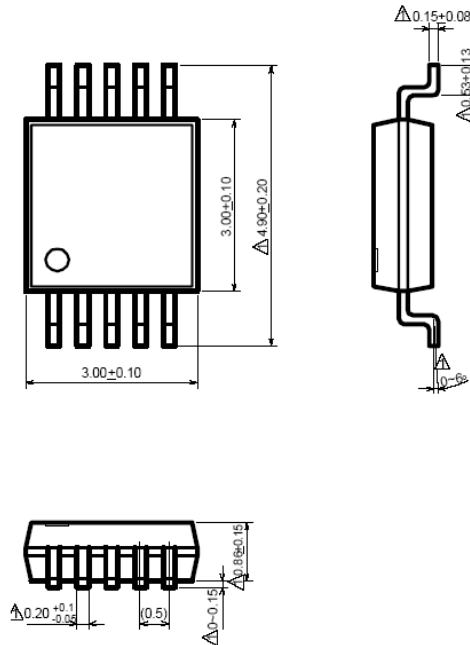

### ● USP-10

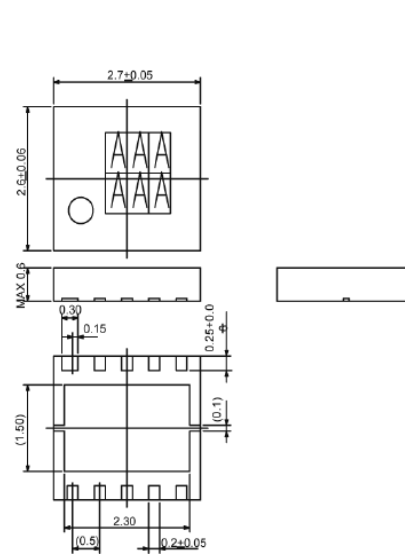

Note: Recommended metal design

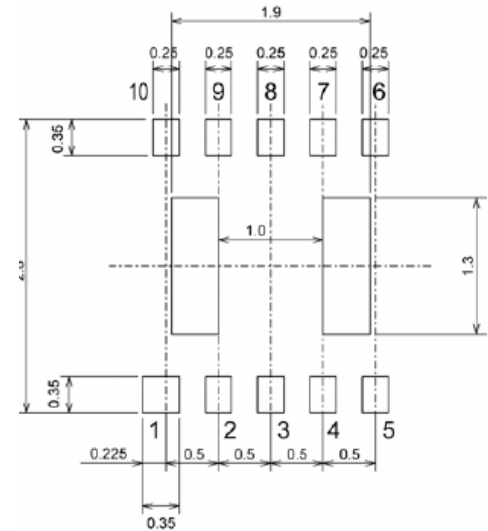

\* Soldering fillet surface is not formed because the sides of the pins are not plated.