

PIN CONFIGURATION

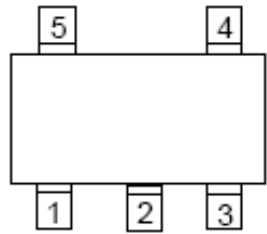

SOT-25
(TOP VIEW)

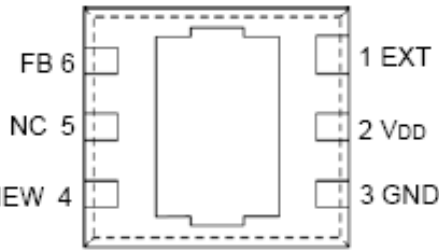

USP-6B
(BOTTOM VIEW)

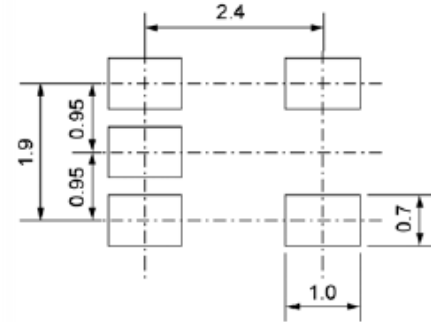
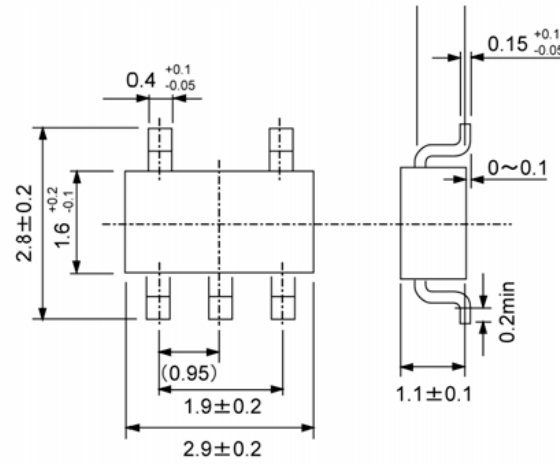

PIN ASSIGNMENT

PIN NUMBER		PIN NAME	FUNCTION
SOT-25	USP-6B		
1	6	FB	Output Resistor Connection
2	2	VDD	Supply Voltage
3	4	CE/ Vref	Serves as Both Chip Enable Pin and Reference Voltage Apply Pin.
4	3	GND	Ground
5	1	EXT	External Transistor Connection
-	5	NC	No Connection

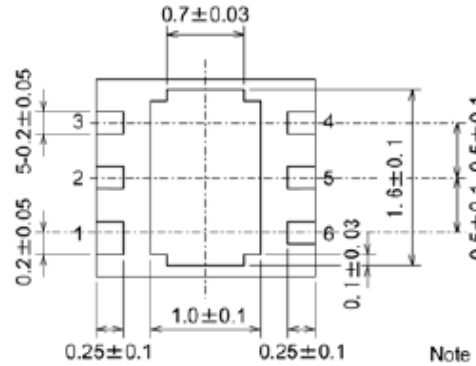

Note : Pin 1 is larger than the other pins.

USB-6B

Note: Recommended metal design

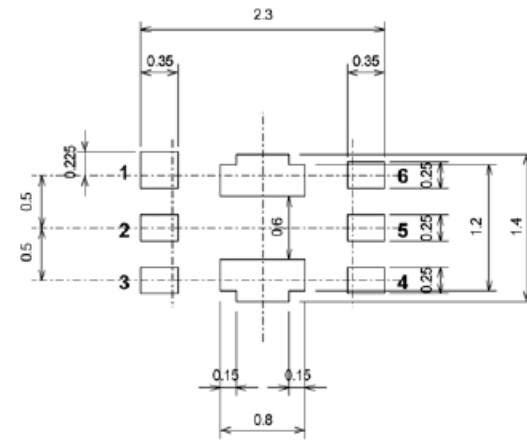
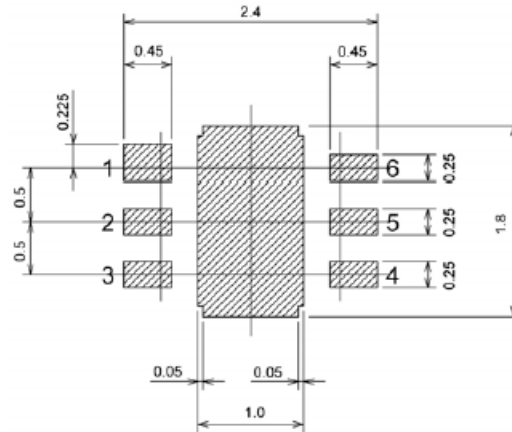

USP-6B

